



RDWC



RDWC BLACK SERIES -

Designed, manufactured and distributed by

ALIEN[®]
THE EVOLUTION OF HYDROPONICS

SET UP INSTRUCTIONS 

Follow this step by step guide to complete the installation of your system.

SYSTEM SET-UP

- 1 Fit the 32mm threaded fittings into the holes at the bottom of the pots. The rubber washer must be on the outside then secure the nut with the
to
5 spanner provided. Bird's eye view images are provided to explain which fittings to use on 2, 3 or 4 row systems.
- 6 Fit a 32mm straight to the header pot and cut a piece of 32mm pipe. Fit a 32mm barbed tee. The header pot can be located outside of the grow room, however you may need extra pipe. Heat the ends of the pipe in some hot water. This will make fitting easier.

Note: The header pot is supplied with a single water pump for recirculating the system. If using a water chiller, a separate water pump is required and can be installed as shown. Follow the chiller manufacturers recommendations for pump sizing. The JET-STREAM™ water pumps can be purchased at alienhydroponics.co.uk

- 7 Place your pots in the desired location and measure the distance between
to
9 the barbed fittings. Take note of the maximum recommended pipe lengths. Cut and fit the 32mm pipe. The black 19mm pipe connects the reducing tee or tee's to the green hose tail on the header pot.

As a guide: 20L pots are recommended for 4 pots per square meter.
36L pots are recommended for 4 pots per 1.2sqm.

Examples:

2 x 2m tent – 16 pot 20L system
2.4 x 2.4m tent – 16 pot 36L system

- 10 Fit the rubber elbow to the Jet-Stream air pump and secure with clips. Place the air pump in the desired location, preferably raised above the pots to avoid water returning to the pump in the event of a power cut.
- 11 Fit a piece of 16mm pipe inside the rubber elbow and secure with the clip. Fit a 16mm tee in line with the first row of pots.
- 12 Fit the pot clips to the slot on the side of the pots.
- 13 Run a piece of pipe from the tee up to the pot clip and fit an airline connector as shown.
- 14
to
16 2, 3 and 4 row system airlines are shown here.
- 17 Complete the airline along each row and put a 16mm blank at the end of each line.
- 18 Place one air stone and sucker in the bottom of each pot and connect the
19 stone to the airline connector with 4mm pipe.
- 20 Place the lids and net pots in position. If your system is the 36L version
21 then you also have the lid surrounds.

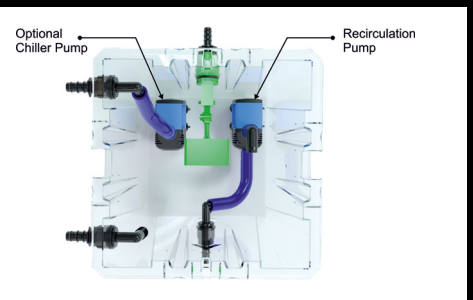
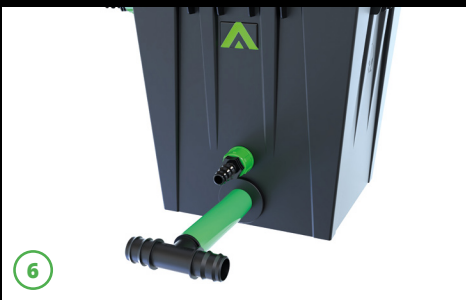
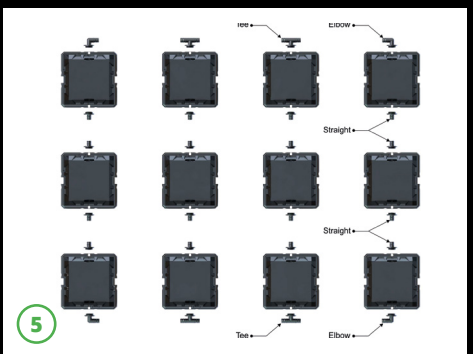
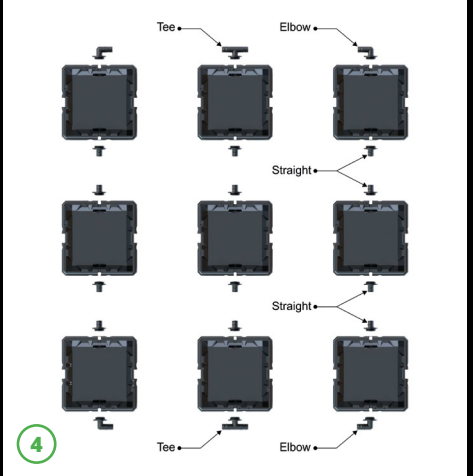
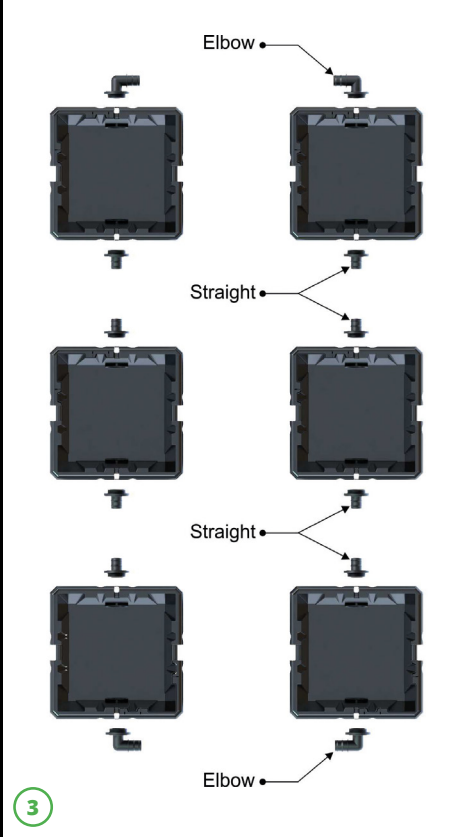
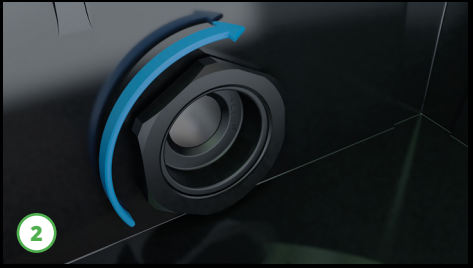
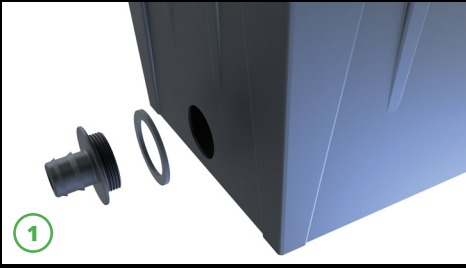

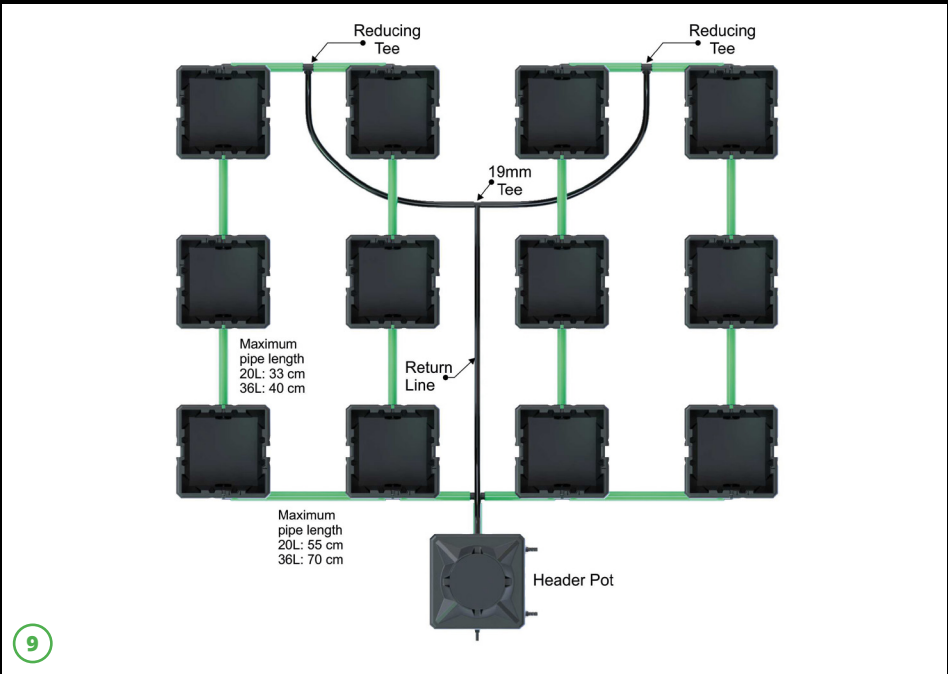
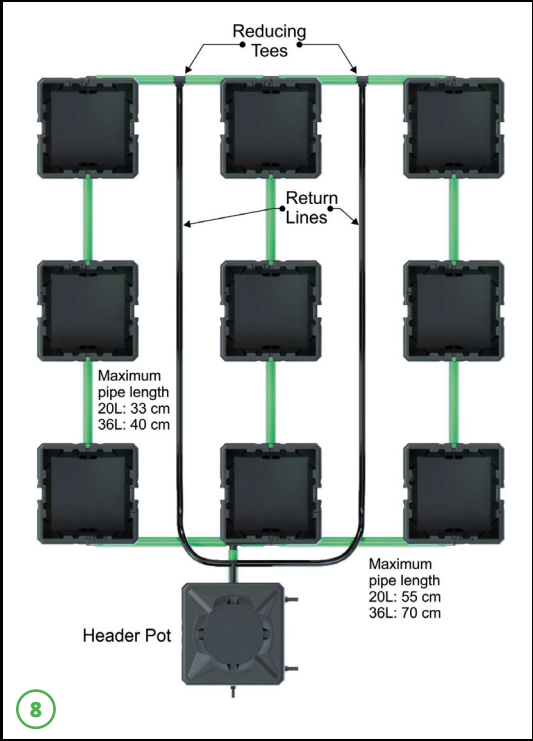
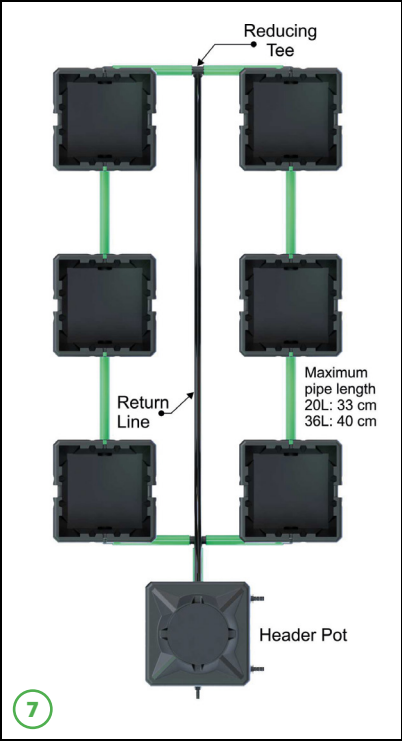

Water Chiller installation

- 22 If you are using a water chiller this diagram shows how to connect the pipes to the header pot. Ideally, the water temperature should be set to 18-20°C.

CAMO® Tank

- 23a Assemble the tank using the leaflet provided. The tank can be located inside or outside of the grow room. Connect the barbed valve tap at the bottom of the tank to the green hose tail on the back of the header pot. The tank will feed the system to ensure the nutrient solution level is maintained.
- 23b

SYSTEM OPERATION

Filling the system

- 24 Use a hose pipe to fill the system. When the float valve in the header is level, the system is full. Do not turn the water pump on until the system is at least half full to avoid an air lock in the water pump. At this stage the CAMO® Tank can remain empty as small plants have enough nutrient solution in the system to support them for some time.

Adding Nutrients

- 25 Add nutrients directly to the header and let the system recirculate for some time before taking a reading. Adjust accordingly. Do the same for PH down.
- 26 Ideally let the system recirculate overnight to allow the water to reach a habitable temperature for the plants. Cold water can shock the plants.

Planting into the system

- 27 Put a layer of substrate into the bottom of the net pot level with the raised grid.
- 28 Water the cutting before transplanting. Place the rooted cutting into the pot and fill the remaining void with substrate.
- to

30

Draining the system

- 31 To perform a nutrient change or to drain the system, simply connect a pipe to the barbed fitting on the recirculation pump. To refill the system you can use the CAMO® Tank to prepare a fresh batch the day before or if the tank isn't large enough then you can directly fill the system with a hose pipe as long as the water is at least 17 degrees so to avoid plant shock. If using the hose pipe method add a small amount of nutrients to the header as the system is filling.

Check the blog on alienhydroponics.co.uk for further info & updates.

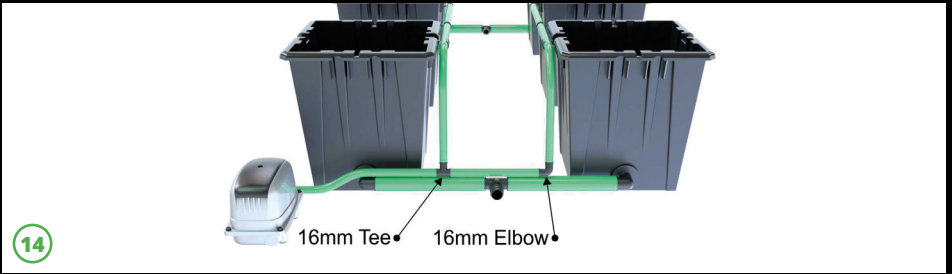
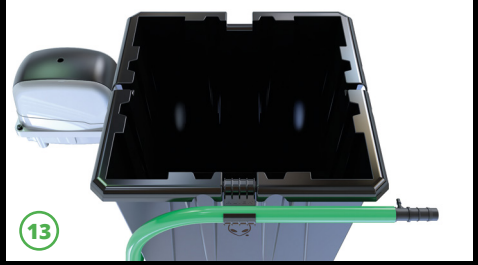
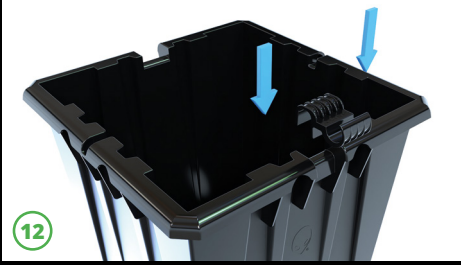

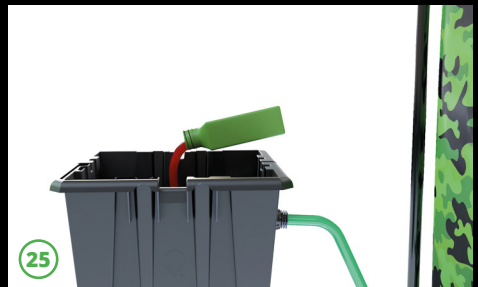
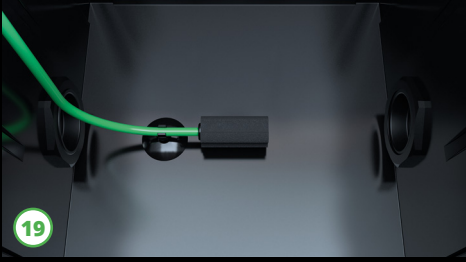
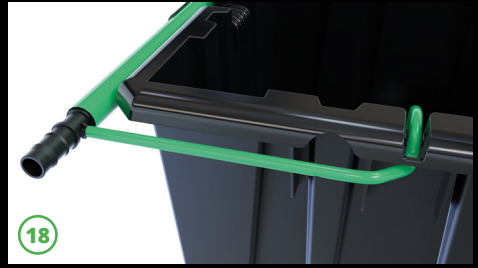
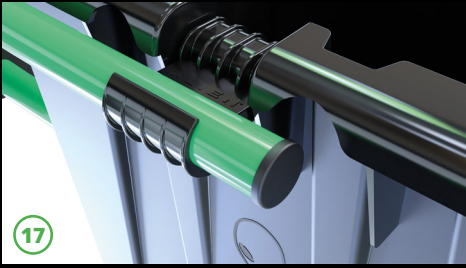



26



27



28



29



30

Connect Hose

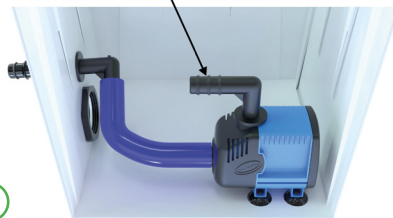

31

Use **ROOT ROT X™** in your system to prevent Pythium, maintain a healthy white root zone and sterilise water lines.

- ELIMINATES PYTHIUM
- BREAKS DOWN BIOFILM
- INHIBITS BIOFILM REGENERATION
- ROOTS STAY HEALTHY & WHITE
- DISSOLVES NUTRIENT BUILD-UP
- PH NEUTRAL

USES:

- CLEAN CUTTINGS
- FLUSHING STAGE
- POWDERY MILDEW
- STERILISE EQUIPMENT

Available online:

 alienhydroponics.co.uk

